



PUTTING YOUR OIL STORAGE IN

SAFE HANDS

WITH KINGSPAN TITAN



Issue No. 4: March 2015
End user must return the enclosed guarantee card

2 Installation Instructions

These instructions should be read in their entirety before commencing installation of the tank.

- A risk assessment must be carried out with reference to OFTEC TI/133D in Technical Book 3 to determine if the installation requires a bunded tank.
- Installation should meet current Building Control / Environment Agency / Pollution Control guidelines.
- Refer to OFTEC Technical Book 3 and BS5410 : Part 1 and Part 2 for requirements on location, installation and maintenance.
- For all tank installation and maintenance, please take into consideration Health & Safety / Local Building Regulations.
- Indoor installations need to meet BS5410, Parts 1 and 2 and OFTEC Technical Book 3.
- For commercial and industrial installations refer to BS5410 : Part 2 and OFTEC Technical Book 3.
- For agricultural installations refer to OFTEC Technical Book 3.
- Where the tank has to be raised above ground level to provide a gravity flow of oil to an appliance the installation should meet OFTEC guidelines and BS5410 : Parts 1 and 2.
- The tank must be installed directly on a level, secure and non-combustible base. If the tank is raised to provide a gravity oil supply, the base must be raised also so that the tank is installed directly on it. Please refer to OFTEC Technical Book 3.
- Determine if tank needs to be secured in place in exposed conditions. **Do not drill holes in the tank.**
- Determine if a Tigerloop de-aerator should be used.
- Consult *table 2* for recommended fuel supply pipe sizes for use with a Tigerloop de-aerator.
- All associated pipe work must be supported independently so as not to put any strain on the tank.
- For vapourising appliances bottom outlets are preferred, however, if a top outlet tank is used a lift pump will be required – consult the appliance manufacturer for technical advice.
- For bottom outlet, the length of pipe run, tank height and boiler requirements will determine the outlet size. Top outlets are treated as a separate item (see *table 2*).
- The Talking Titan / Smart Tank single skin tanks and FuelMaster bunded dispensing tanks are supplied with electronic contents gauges as standard (WatchmanSonic). EcoSafe bunded tanks are supplied with an electronic contents gauge and alarm as standard (WatchmanAlarm).

- Buried pipe work needs to meet OFTEC Technical Book 3 and BS5410 : Part 1.
- Talking Titan / Smart Tank single skin tanks and EcoSafe bundled range of tanks may be fitted with bottom or top outlets, although the Environment Agency prefers top outlet tanks.
- Prior to installing inspect for damage, if damaged do not install.
- Connections must be held in place when tightening. Do not over tighten.
- Use only approved sealing compound such as Haldite. Do not use boss white.
- Never solder joints / connections.
- The guarantee card in this booklet should be returned to the manufacturer or it can be completed online at www.kingspanenviro.com located on the home page.
- The tank serial number must be recorded on the guarantee card to validate warranty. This number is usually located around lid area and on larger tanks on the rib above the outlet.
- The tank must be installed by a suitably qualified engineer with OFTEC registration or equivalent.
- When dispensing fuel, a single skin tank with hose and nozzle is not suitable. A FuelMaster must be used.
- The warranty is dependant on the tank being correctly installed and maintained by a suitably qualified engineer.
- **THE TANK MUST NOT BE FILLED AT A RATE EXCEEDING 400 LITRES PER MINUTE.**
- For further advice, contact the OFTEC helpline on 0845 6585 080 or visit www.oftec.org.

After installation, please ensure that this instruction booklet is left with the end user for future reference.

ES1300



4 Installation Instructions

- Tanks with a capacity not exceeding 3400 litres (serving single family dwellings and where the boiler output does not exceed 45 kW) should be fitted not less than 1.8 metres from a building, and not less than 760mm from the site boundary and not less than 1.8 metres from a flue outlet. (See *figure 1* on page 6).
 - Where the above clearances cannot be achieved, the protection measures noted in BS5410 : Part 1 must be provided by means of a 30 minutes fire resistant wall which extends at least 300mm above and beyond the ends of the tank.
 - It will be necessary to protect exposed eaves forming part of a roof within 1.8 metres of the top of an oil storage tank to provide 30 minutes fire resistance. Cladding should be applied to the eaves in order to prevent fire spreading to the roof.
 - Larger houses with a capacity in excess of 3,500 litres, or where the boiler output exceeds 45 kW, have different requirements, and reference should be made to BS 5410 : Part 2 and OFTEC Technical book 3.
 - For commercial and industrial installations refer to BS5410 : Part 2 and OFTEC Technical Book 3.
- For agricultural installations refer to OFTEC Technical Book 3.
 - **Ensure the entire base of the tank is supported with a non-combustible base (minimum 45mm in thickness) extending 300mm on all sides.**

ES1225



Figure 1: Class 1 Tank Installation near combustible buildings and boundaries with clearances required when additional fire protection is not provided.
(Printed with the permission of OFTEC)

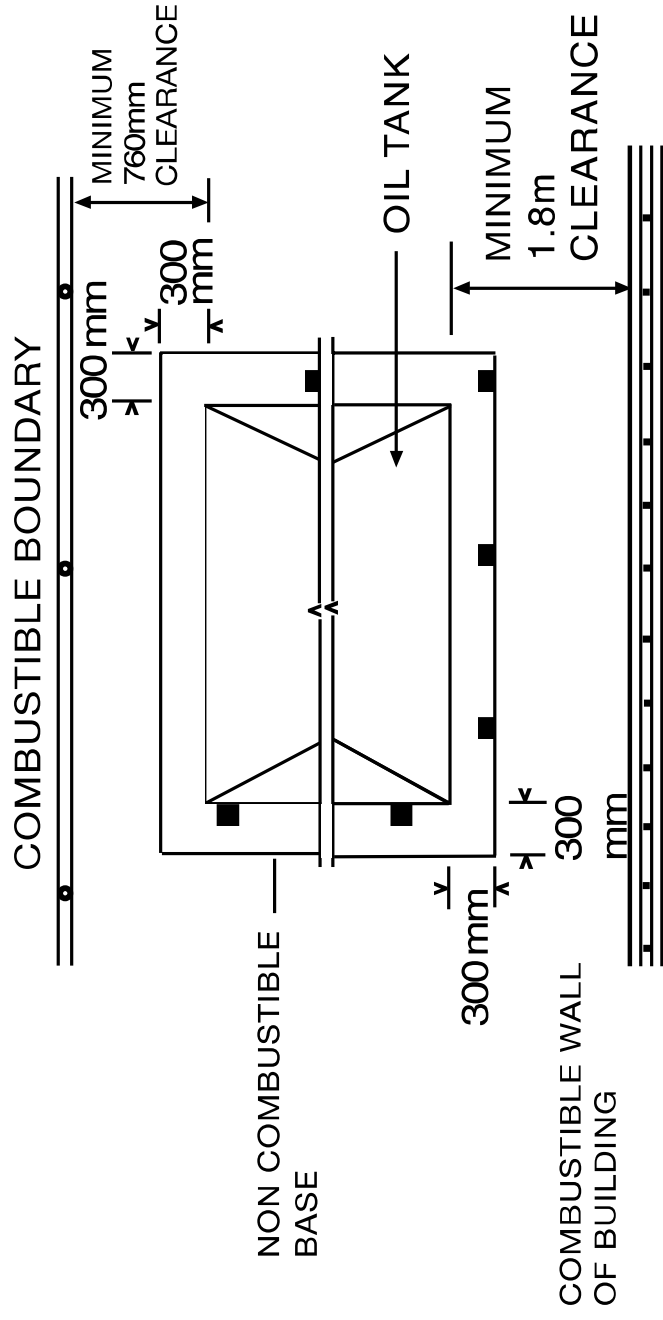

Bottom outlet Tankpac for Talking Titan / Smart Tank single skin and EcoSafe banded range of tanks consists of: Heldite, brush applicator, PTFE tape, reducer or straight male to male nipple, depending on outlet size, WatchmanSonic or WatchmanAlarm transmitter, receiver, shut-off valve / filter combined and instruction booklet.

- Standard outlet on the tank is a 1" BSP female thread which can take either 10mm, 1/2" or 1" Tankpac.
- Standard Tankpac kit up to and including the V2500 has a 10mm outlet. For larger tanks the standard Tankpac is 1", see *table 1* for all sizes available.

10mm Bottom Outlet Tankpac

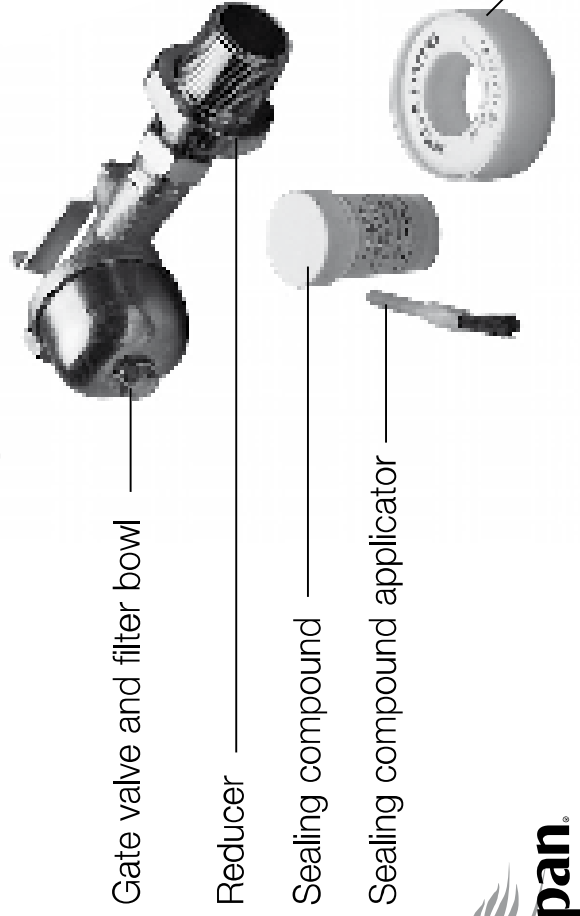

- 10mm Tankpac kits have a hydraulic fitting. Fitting needs to be seated and aligned before and during tightening.
- Do not attempt to attach a larger connection to the 10mm filter bowl, as this will cause leaks and invalidate the warranty.
- Tankpacs are guaranteed for one year.
- For maintenance repair kits, see *table 4*.
- Filter bowl may be orientated to suit the installation, as shown in *figure 3*.

Retrofit kits are available upon request.



Figure 2: Typical Bottom Outlet Arrangement

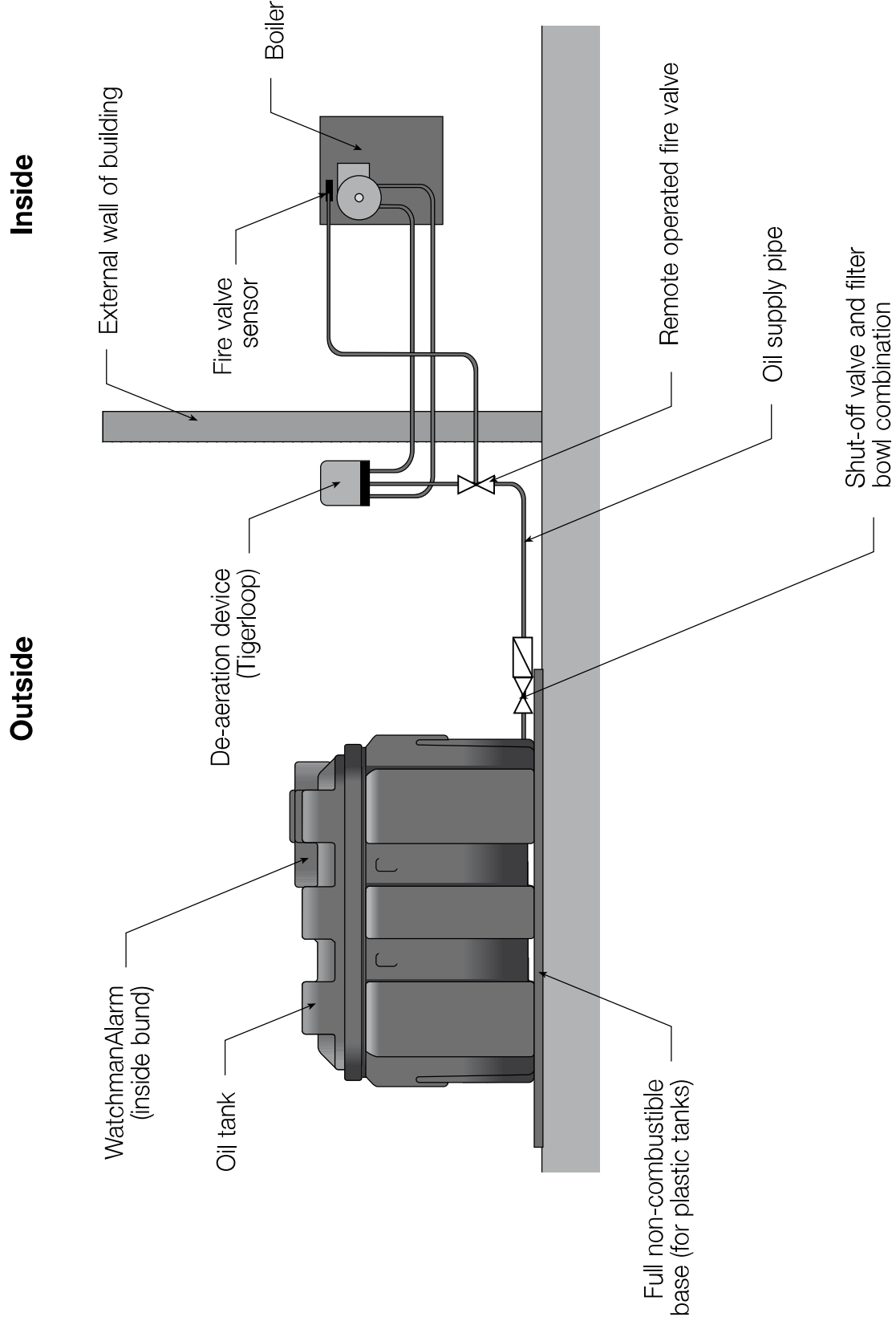

Figure 3: Bottom Outlet

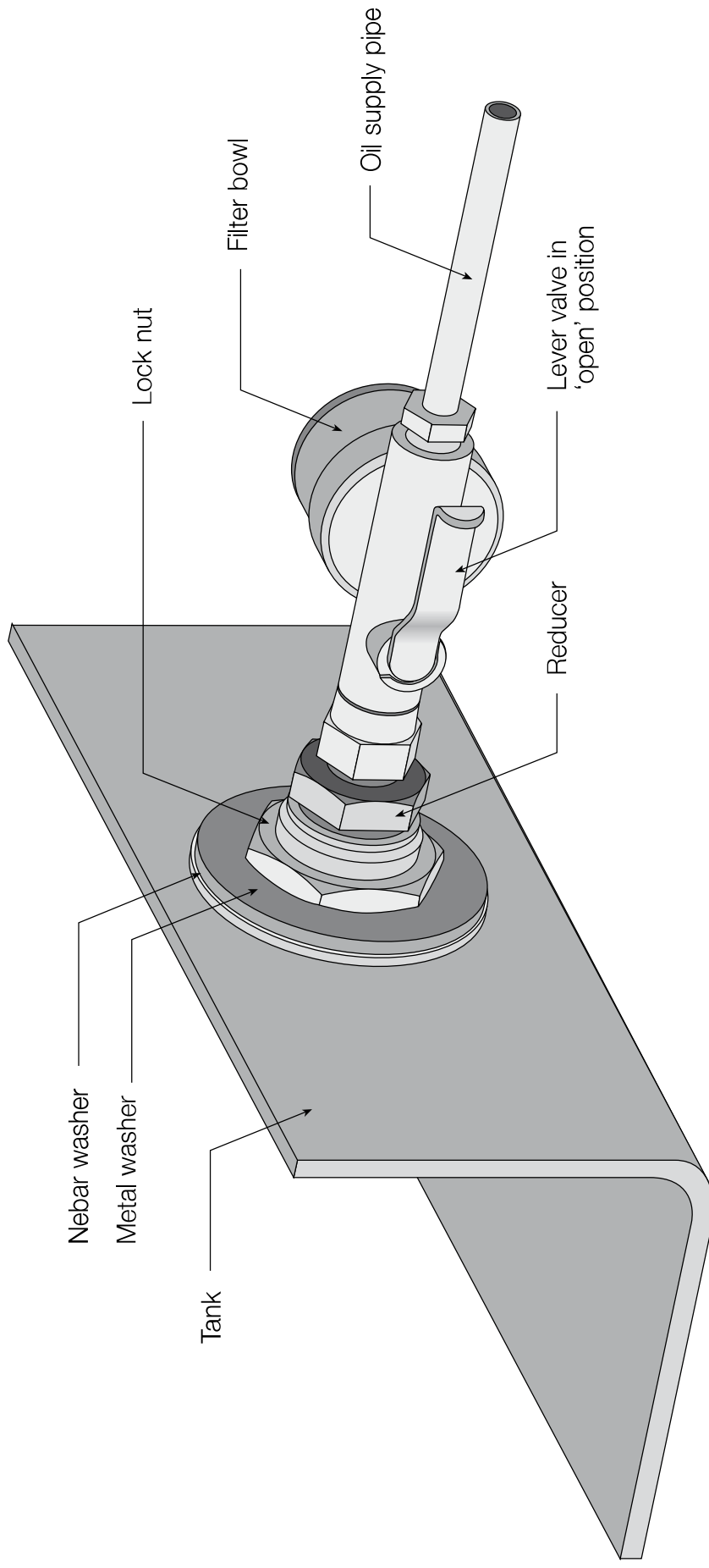

Table 1: Tankpac Options (only on EcoSafe, Smart Tanks and Tanking Titan)

Product	Outlet size	10mm Tankpac	1/2" Tankpac	1" Tankpac
Single skin tanks				
V1300TT	1"	●	○	○
V2500TT	1"	●	○	○
V3500TT	1"	○	○	●
V6000TT	1"	○	○	●
V10000TT	1"	○	○	●
R1000TT	1"	●	○	○
R1225TT	1"	●	○	○
LP1200TT	1"	●	○	○
H1300TT	1"	●	○	○
H1800TT	1"	●	○	○
H2500TT	1"	●	○	○
Bunded tanks				
ES1000	1" Bottom	●	○	○
ESLP1200	1" Bottom	●	○	○
ES1225	1" Bottom	●	○	○
ES1300	1" Bottom	●	○	○
ESV1300	1" Bottom	●	○	○
ESSL1400	1" Bottom	●	○	○
ES1800	1" Bottom	●	○	○
ES2500	1" Bottom	●	○	○
ESV2500	1" Bottom	●	○	○
ES3500	1" Bottom	○	○	●
ES6000	1" Bottom	○	○	●
ES9000	1" Bottom	○	○	●
ESSL4000	Top outlet only	●	○	○

● - Standard ○ - Optional

Top outlet available on single skin and bunded tanks on request. Connection for extended filling pipe is available on request.

Tel: +44 (0) 28 3836 4444 (UK) Tel: +353 (0) 42 9690022 (ROI)



Top outlet Tankpac for Talking Titan / Smart Tank single skin tanks, FuelMaster bunded dispensing tanks and EcoSafe bunded range of tanks consists of top outlet kit (figure 5), WatchmanSonic or WatchmanAlarm transmitter, receiver and installation and user manuals.

- Consult OFTEC Technical Book 3 for installation guidelines.
- For guidance on supply pipe sizes, see *table 2*. Do not oversize pipes.
- Care should be taken to minimise the number of joints in the supply pipe.
- The supply pipe must be the same diameter from the tank to the boiler.
- The top outlet (see *figure 5*) is fitted with a port for a return pipe and includes a non-return valve and shut-off valve. See manufacturer's instructions enclosed.
- Single feed top outlet is not recommended for supplying multiple appliances, a separate supply line is required for each and these can be factory fitted on request.
- Flexible oil line can be routed through the outer bund where the top and bottom halves meet.

- Adjustable anti-siphon valve and Tigerloop can be supplied as optional extras.
- Check oil supply line for air leaks using a vacuum gauge and rectify as necessary.
- Do not use right angle connectors as this may lead to a build up of air / gas and create an air lock.
- Use a vacuum pump to prime supply line to boiler, for efficient operation all air must be expelled.
- Top outlet will accept 8, 10 or 12mm supply pipe.
- It is recommended that a Tigerloop de-aerator (optional extra) be used. See manufacturer's instructions.
- To prevent oil loss in the case where the supply line is fractured, it is necessary to fit an anti-siphon valve. See manufacturer's instructions.
- For vapourising appliances bottom outlets are preferred, however, if a top outlet tank is used a lift pump will be required – consult the appliance manufacturer for technical advice.
- Fittings are guaranteed for one year.

Retrofit kits consisting of top outlet parts and Tankpacs are available on request.

Figure 4: Typical Top Outlet Arrangement

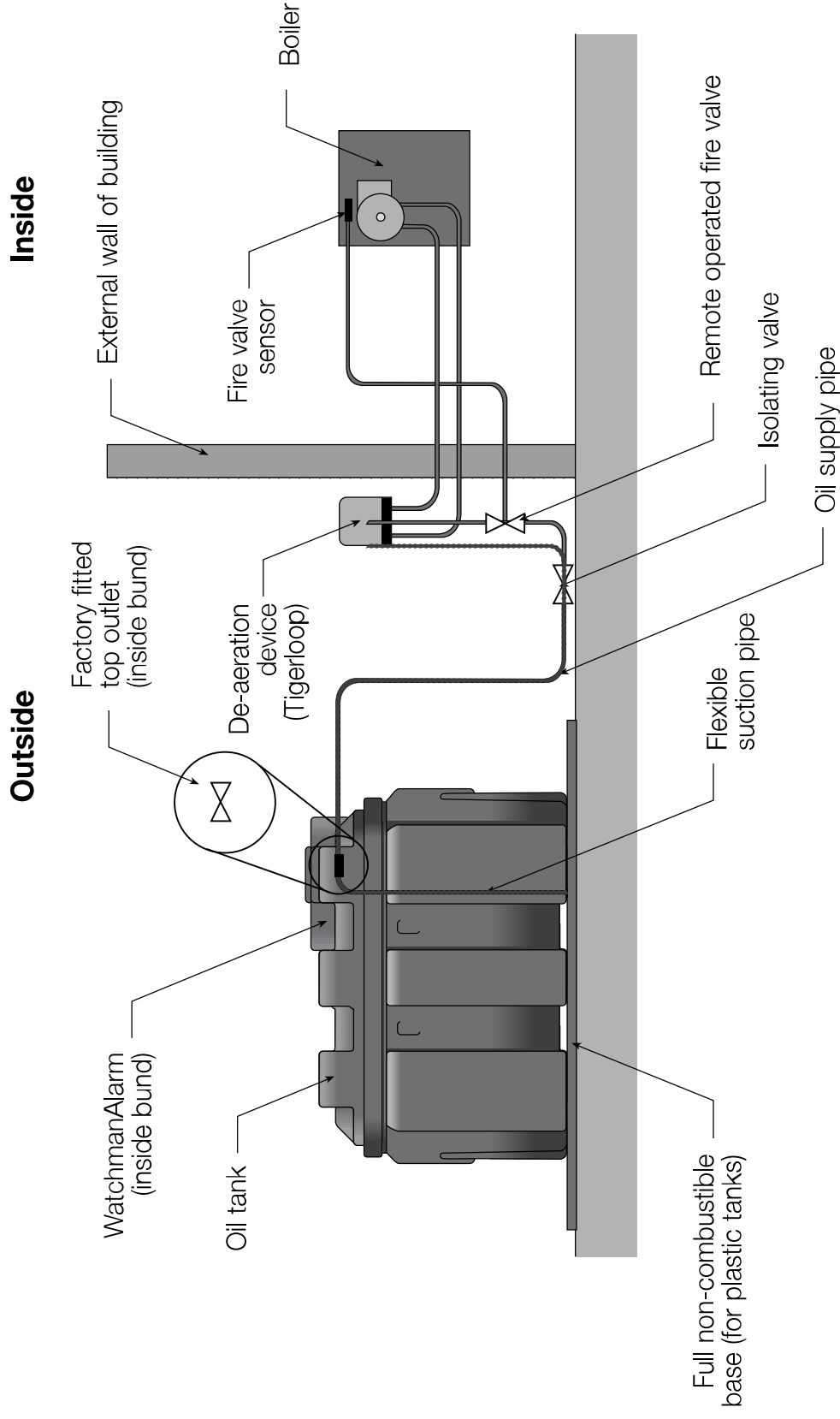
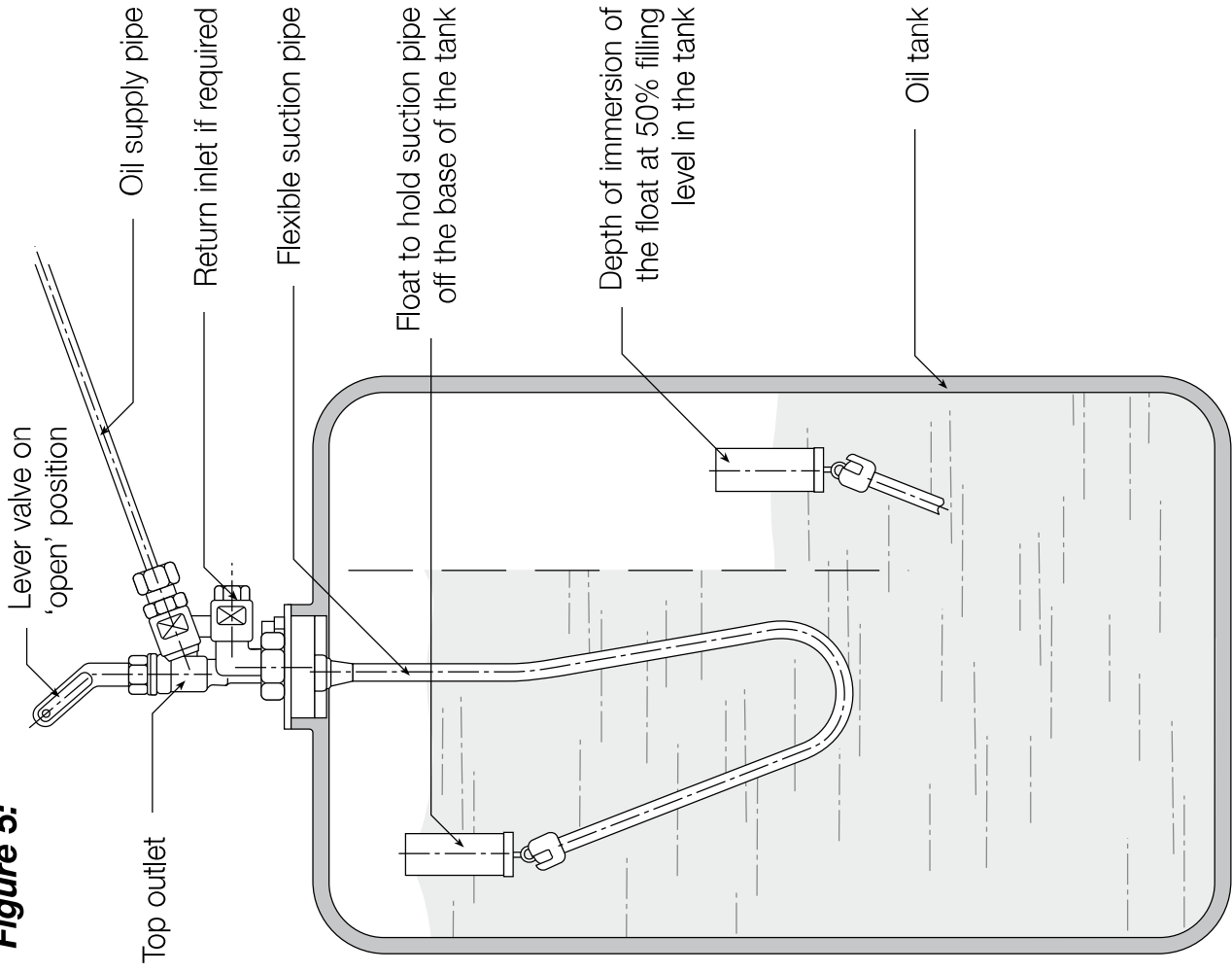

Table 2: Pipeline Sizes

Copper Pipes Ext. Dia (mm)	Recommended Pipe Sizes for Oil Burners up to 30kW Output or Nozzle Capacity of 2.5 KG/H										
	TOTAL SUCTION HEAD (M)										
TOTAL LENGTH OF PIPE (M)	0	0.5	1	1.5	2	2.5	3	3.5	4	4.5	
0	6	6	6	6	6	6	6	6	6	6	4.5
10	6	6	6	6	6	6	6	6	6	6	10
15	6	6	6	6	6	6	6	6	6	6	10
20	6	6	6	6	6	6	6	6	6	6	-
25	6	6	6	6	6	6	6	6	6	6	-
30	6	6	6	6	6	6	6	6	6	6	-
40	6	6	6	6	6	6	6	6	6	6	-
50	6	6	6	6	6	6	6	6	6	6	-
60	6	6	6	6	6	6	6	6	6	6	-
70	6	6	6	6	6	6	6	6	6	6	-
80	6	6	6	6	6	6	6	6	6	6	-
90	6	6	6	6	6	6	6	6	6	6	-
100	6	6	6	6	6	6	6	6	6	6	-

Figure 5:



De-aeration Device – Tigerloop/Tigerloop Combi

- A device fitted in the oil line close to the heating appliance to help the drawing of oil up to a level higher than the level of oil in the tank. It does this by removing the air and vapour created when the pump in the oil boiler applies suction to the high-level oil line.
- Tigerloop devices must not be installed inside buildings.
- A Tigerloop Combi is as above, and incorporates a filter.
- Continuous gassing / air bubbles in the Tigerloop means that air is getting into the system. This must be rectified.
- An instruction leaflet is supplied with each Tigerloop.
- Tigerloop is guaranteed for one year.



Tigerloop



**Tigerloop
Combi**

Anti-Siphon Valve

- A valve that will prevent the oil in the tank being siphoned off should a leakage occur in the suction pipe between the anti-siphon valve and the burner.
- Valve will accept 6, 8, 10 and 12mm supply pipe.
- Protection level adjustable between 1m – 1.8m.
- An instruction leaflet is supplied with each anti-siphon valve.
- The anti-siphon valve is guaranteed for one year.



**Anti-Siphon
Valve**

SpillStop Information

The SpillStop is an overfill prevention device that ensures the environment is protected if an attempt is made to overfill the tank. This device with a 2" BSP threaded connection shuts off the fill point once fuel reaches 95% of the tank volume (figure 6).

- Approved to BS EN 13616: 2004 by TÜV Nord CERT, for use in installations for the storage of fuel intended for the supply of building heating/cooling systems.
- Meets the requirements of OFTEC OFS T100.
- For use only with tanks filled by a pressure pump and a delivery hose with a shut-off valve, operating at a minimum of 150mbar (15kPa) and a maximum 6 bar (0.6MPa).
- Suitable for delivery fuel flow rates from 35 litres / minute up to 600 litres / minute.
- SpillStop is guaranteed for one year.

Note: General industry advice directs that plastic storage tanks must not be filled at a rate exceeding 400 litres per minute.

Operation / User Guide

- Remove 2" yellow screwcap.
- Where possible, visually check the hole on the cone part of the SpillStop in case something has become trapped.
- Securely screw the 2" delivery hose to the SpillStop, the delivery hose must have a shut off valve.
- Fill tank in normal manner.
- When the SpillStop is activated, the delivery flow rate will be restricted to a maximum of 2.5 litres / minute.
- Close the shut off valve on the 2" delivery hose.
- Turn off the delivery pump.
- Wait 1 minute and then disconnect the delivery hose from the SpillStop.
- Securely fasten screwcap.

Maintenance

It is recommended where possible, that the hole in the centre of the cone shaped valve be checked during each annual tank check for any blockages. This is visible when looking down into the 2" threaded connection.

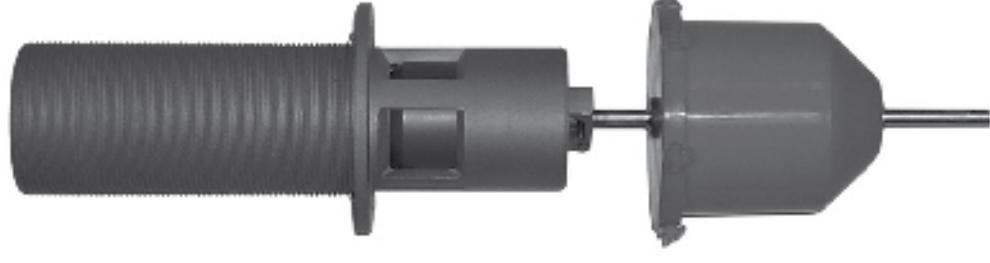

Figure 6: SpillStop overfill prevention device

Table 3: FuelMaster+ Options

Product Code	Capacity (litres)	Pump Type	Auto-matic Nozzle	Flow Meter	Hose Length (m)	TMS (optional)	10 Micron P & W Filter
FMPSL1222510PW	1225	230 VOLT	•	•	4	o	•
FMPH1300ROT	1300	ROTARY	X	X	4	X	X
FMPH130012V10PW	1300	12 VOLT	•	•	4	o	•
FMPH1300110V10PW	1300	110 VOLT	•	•	4	o	•
FMPH130010PW	1300	230 VOLT	•	•	4	o	•
FMPH2500ROT	2500	ROTARY	X	X	4	X	X
FMPH250012V10PW	2500	12 VOLT	•	•	4	o	•
FMPH2500110V10PW	2500	110 VOLT	•	•	4	o	•
FMPH250010PW	2500	230 VOLT	•	•	4	o	•
FMPV250010PW	3500	230 VOLT	•	•	6	o	•
FMPSL400010PW	4000	230 VOLT	•	•	6	o	•
FMPV500010PW	5000	230 VOLT	•	•	6	o	•
FMPV900010PW	9000	230 VOLT	•	•	6	o	•

• STANDARD
o OPTIONAL

X NOT AVAILABLE

FuelMaster Information

- Manufacturer's instructions are supplied with the tank, including installation, maintenance and trouble shooting guide.
- Pump should be maintained in accordance with the pump manufacturer's instructions.
- For use with diesel fuel, viscosity from 2 to 5.35 Cst at 37.8°C. Minimum flash point 55°C.
- All rotary pumps must be primed before use in accordance with the instruction leaflet.
- Electrical connection to be made by a suitably qualified electrician.
- For FuelMaster options refer to table 3, left.
- Fuel management systems are available on request.
- Pumps are not suitable for retail purposes.
- Pump and pump accessories are guaranteed for one year.
- Delivery/ suction hoses are guaranteed for three months.

Tank maintenance must be carried out annually by an suitably qualified engineer with OFTEC registration or equivalent. A check should be made on the following items;

- The general condition of the tank.
- Determine if there are any oil leaks.
- The tank for water ingress. Determine the cause and rectify.
- The condition of all pipework and fittings.
- The condition of filling and venting provisions.
- The condition of tank supports.
- The bunded tank: determine if any fluid is present in the bund, determine cause and rectify. Remove fluid as soon as possible and dispose of according to the requisite legislation.
- The condition of measuring devices.
- Check the filter bowl and replace parts as necessary. If spare parts are not readily available please contact your local Titan stockist.
- Ensure that the anti-siphon valve is working according to the manufacturer's instructions.

- Ensure that the Tigerloop de-aerator is working according to the manufacturer's instructions.
- Checks should be made on the condition of the SpillStop, see page 14.

Refer to OFTEC Technical Book 3 for further information on tank maintenance and inspection.

ES1800



The Titan single skin oil storage tank (Standard, Talking Titan and Smart Tank range) is guaranteed for 2 years from the date of purchase against faulty materials or manufacture.

The Titan bunded oil storage tank (EcoSafe and FuelMaster+ range) is guaranteed for 10 years from the date of purchase against faulty materials or manufacture.

The guarantee applies to the original purchaser only, and is not transferrable to subsequent owners.

Provided that the following criteria are adhered to (applicable to all models):

- The enclosed guarantee card is returned to Kingspan Environmental Ltd with evidence of the purchase date.
- The tank is installed and commissioned in accordance with the instructions outlined in the Installation and User Manual.
- The tank is installed and commissioned by a suitably qualified engineer.
- The tank is used for the storage of kerosene (C1/C2) (Single Skin & EcoSafe tanks only), fuel oil (A2), and gas oil/diesel (D), as defined in BS EN 2869. Also automotive diesel as defined in BS EN 590 (including up to 7% biofuel to BS EN 14214). It should be noted that Titan tanks are not suitable for the storage of petrol or liquid petroleum gas (LPG).
- Proof of purchase and evidence of annual inspections by a suitably qualified service engineer are required in the event of a claim.

- The tank has not been subject to misuse, careless handling, faulty installation, or any repairs have not been attempted or carried out other than by Kingspan Environmental Ltd service staff.
- The tank has been purchased by the end user and is not for hire purposes.
- The tank has not been filled at a rate exceeding 400 litres per minute.
- The tank is installed above ground.
- The tank is inspected annually by a suitably qualified service engineer, with records maintained. Immediately upon discovery of any defect in the tank, steps are taken to mitigate loss by contacting the oil supplier and if necessary arrangements are made for the tank to be drained pending the supply of a new tank.
- Immediately upon discovery of any defect you contact the Guarantor and allow a representative to inspect the tank and its surroundings and where necessary carry out any repairs (before any attempts are made to move the tank).
- The guarantee excludes ancillary fittings such as contents measuring gauges or mechanical pumps. Further guarantee information on ancillary fittings and pumps is provided within the manual.
- During the guarantee period, any component of your product which is proved to contain any material defect in workmanship or materials will be exchanged or repaired, at our sole discretion.

In addition (applicable to single skin tanks only):

- If the tank is single skinned, Titan recommend that it should be installed within a secondary container system (a bund), and its base and walls must be impermeable to water and oil.
- For single skinned tanks this guarantee does not confer any rights other than those expressly set out above and does not cover any claims for consequential loss or damage howsoever caused.
- If the single skinned tank has been correctly installed within a secondary container system or bund, then subject to the above, under the guarantee additional rights may be conferred for any claim for consequential loss or damage if caused by faulty manufacture or materials. The Company will determine all such claims.

This guarantee is offered as an extra benefit and does not affect your statutory rights as a consumer. It is provided on the basis that it is applicable for a period of 2 years (Standard, Talking Titan and Smart Tank range) or 10 Years (EcoSafe and FuelMaster+ range) only and it shall expire at the end of the specified period from the date of purchase.

Product	Guarantee Period if Registered
BUNDED HEATING OIL TANKS	10 years
BUNDED FUELMASTER	10 years
BUNDED WASTE OIL TANKS	10 years
SINGLE SKIN HEATING OIL TANKS	2 years
ACCESSORIES	
FUELMASTER SUCTION/DELIVERY HOSES	3 months
ALL OTHER FUELMASTER ACCESSORIES	3 months
WATCHMAN OIL MONITORS	1 year