

Think Tank. Think ENDURATANK

**NEED
MORE HELP?
CALL US ON
01778 562810**



VERTICAL TANK TECHNICAL SPECIFICATION

POTABLE	172225	NON - POTABLE	172125
CAPACITY (Litres)	12500	CAPACITY (Gallons)	2749

A (mm)	2600	B (mm)	2650
C (mm)	620	Standard Outlet	2"

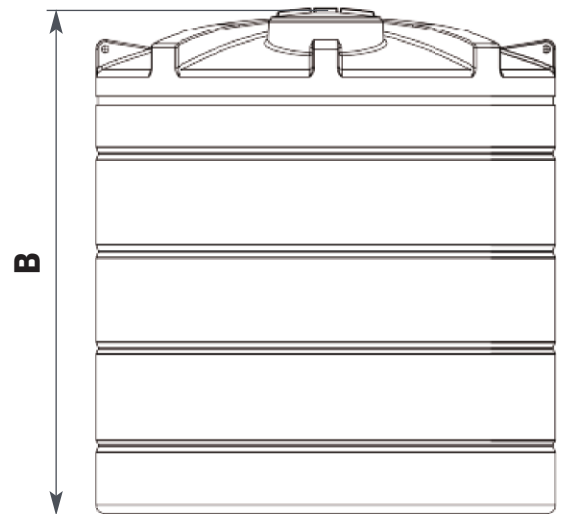
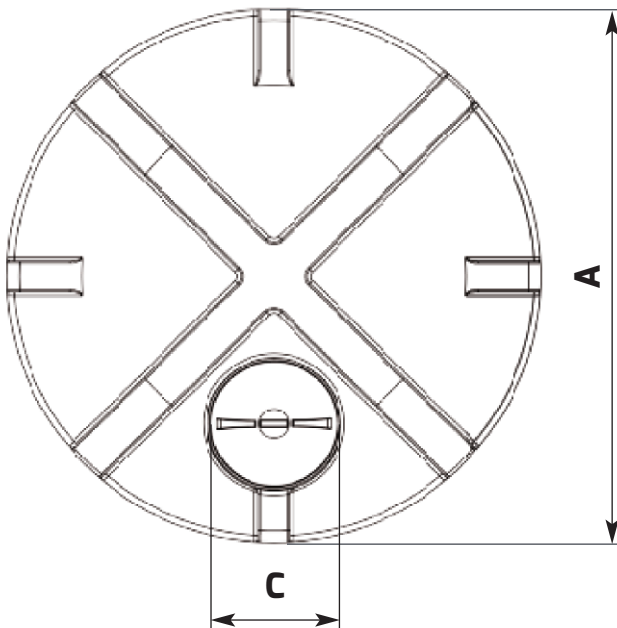

ENDURATANK

© Enduramaxx 2015. Copyright of this drawing is reserved by Enduramaxx. The issue of this drawing is confidential disclosure of its contents, and is made conditional that it is neither disclosed to a third party, nor any item described herein and designed by Enduramaxx is produced either in whole or in part without the written consent of Enduramaxx.



Enduratank part of the Enduramaxx Family
01778 562810 sales@enduratank.co.uk

Visit us at www.enduratank.co.uk